

PRODUCT OVERVIEW

Create lasting and enduring spaces with this wall-mounted, modular and re-configurable metal panel system from Zahner. Moda is a series of lightweight metal panels that are available in four standard sizes and a variety of material and surface options.

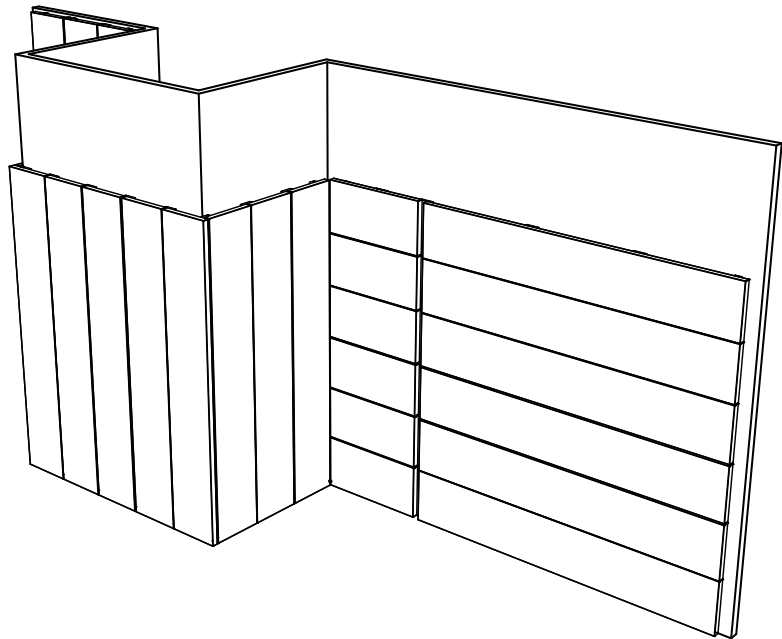

RECOMMENDED TOOLS AND EQUIPMENT

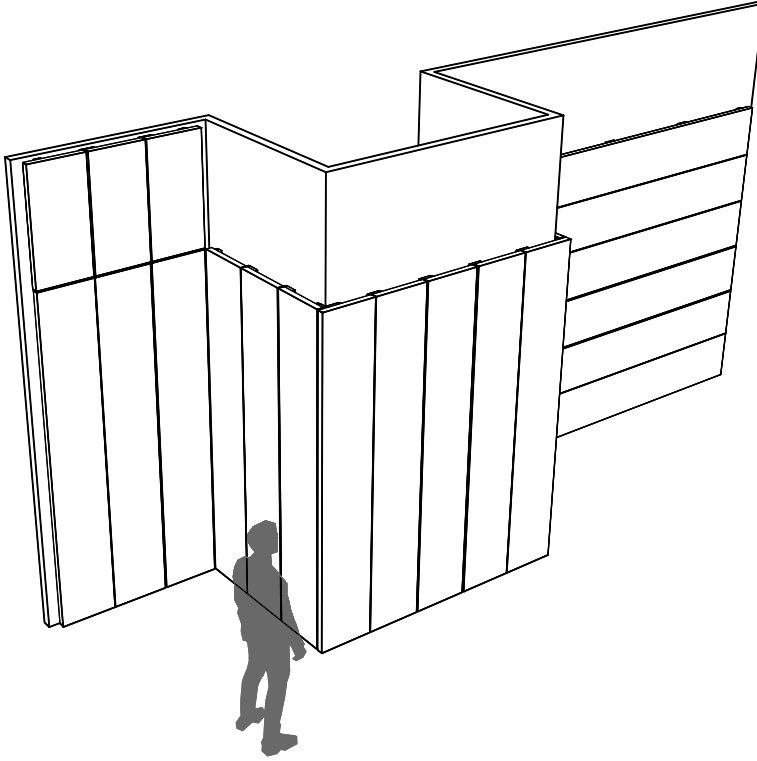

Pencil

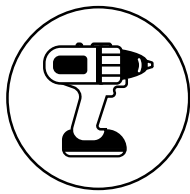

Drill

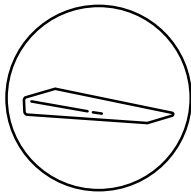

Shims

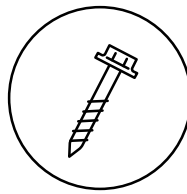

Fasteners

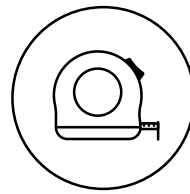

Tape Measure



Gloves

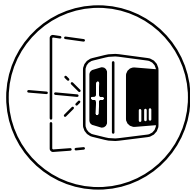

Level

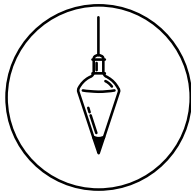

Plumb Bob



Ladder

BEFORE STARTING INSTALLATION

- Read this manual carefully.
- Determine the correct and desired panel layout for your project. The Moda Planner grid is recommended for creating a drawing to help guide your installation.
- Download and print the Moda Detail Set and Moda Datasheet.
- Examine each item carefully to ensure that the item quantity, size, material, finish, and quality matches the order specifications. In the event any discrepancies are found, STOP and contact the Zahner Product team at 816-423-8280 before proceeding.
- A staging area is recommended for checking the layout. Lay out the panels in the space before to ensure panel orientation and alignment are according to product information.

INSTALLATION

General Sequence

1. Plan your work. Making a layout drawing is highly recommended.
2. Mount brackets for any outside corners.
3. Mount brackets for any inside corners.
4. Mount brackets for edge of scope.
5. Mount C-Brackets.
6. Install reveal covers.
7. Install panels.

01. Plan your work

Review the Moda detail set, and make note of the recommended minimum distance from the floor and ceiling.

Use a mounting slot in the Moda hardware as a location for a reference horizontal line. Mark this line across the entire scope of the installation.

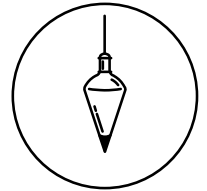
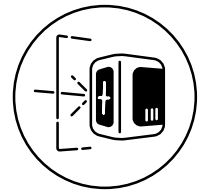
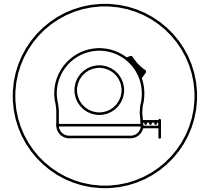
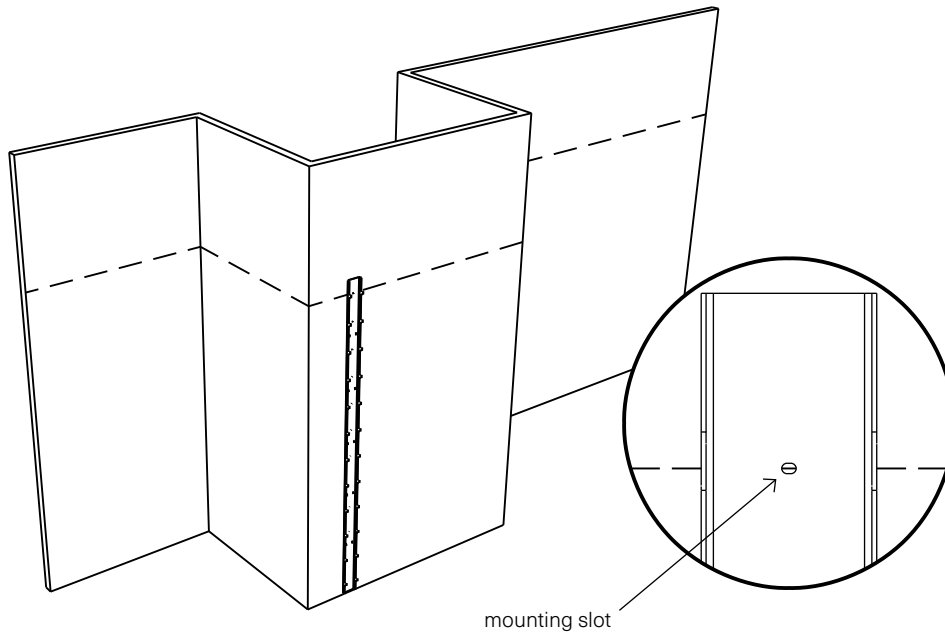

Evaluate your wall for plumb and flatness across the scope of your project. This step is vital for ensuring a smooth installation process and correct and consistent panel alignment.

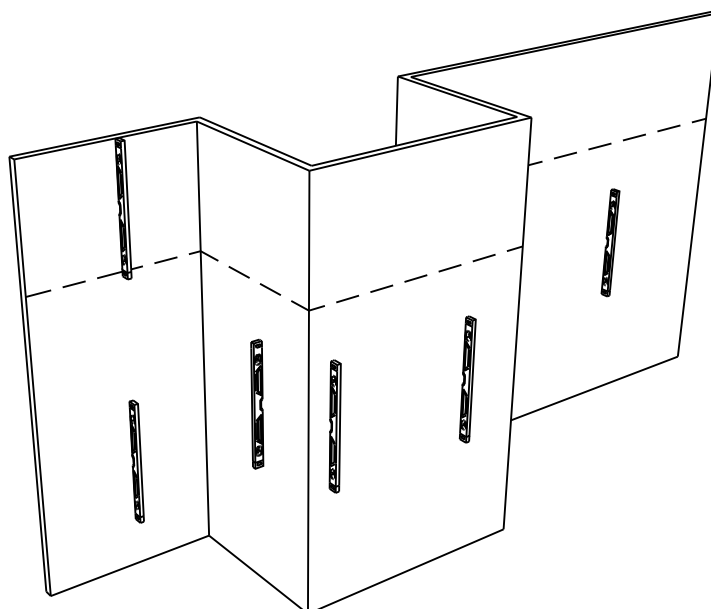

02. Install Brackets for Outside Corners

If your project does not require Outside Corners, skip to the next section.

Place the Moda Corner Bracket against the wall as shown. Measure to confirm the bracket is plumb. Shim if necessary. Mark the hole centers by scribing along the flat end of the openings in the hardware.

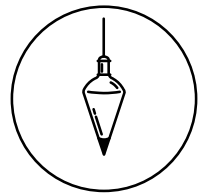
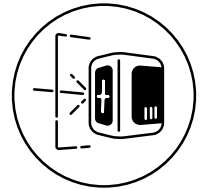
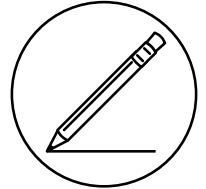
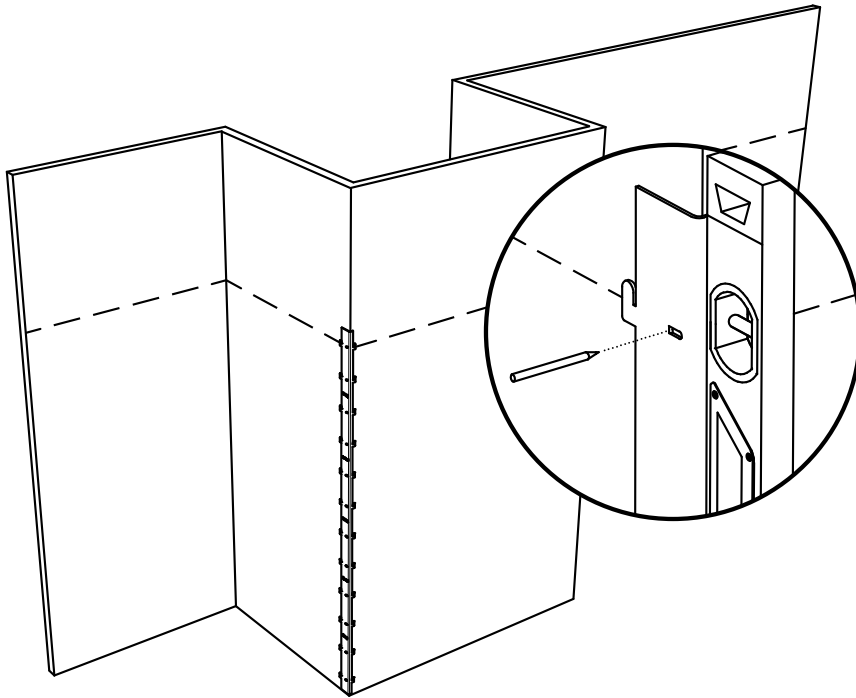

02. Install Brackets for Outside Corners (con't)

Mount the Corner Bracket to the wall. Do not fully tighten the fasteners.

Adjust the position of the bracket. Measure to confirm that the bracket is both straight and plumb.

Shim the bracket if necessary. Confirm proper alignment with adjacent wall using a C-Bracket.

Tighten all fasteners.

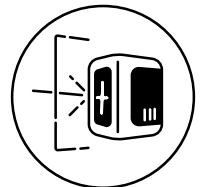
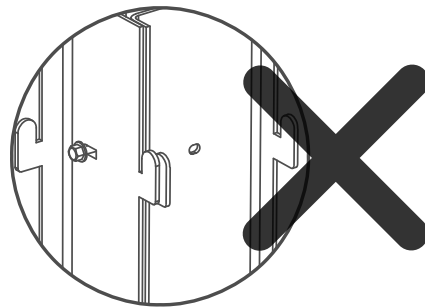
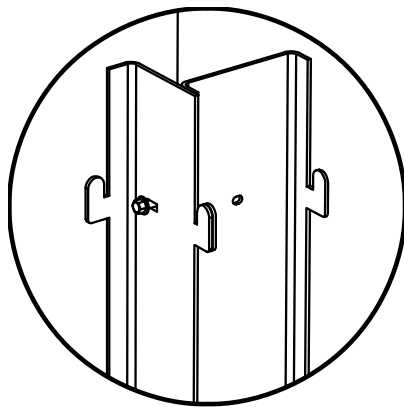
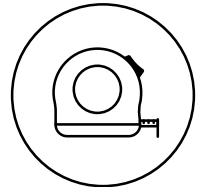
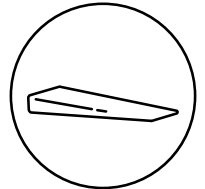
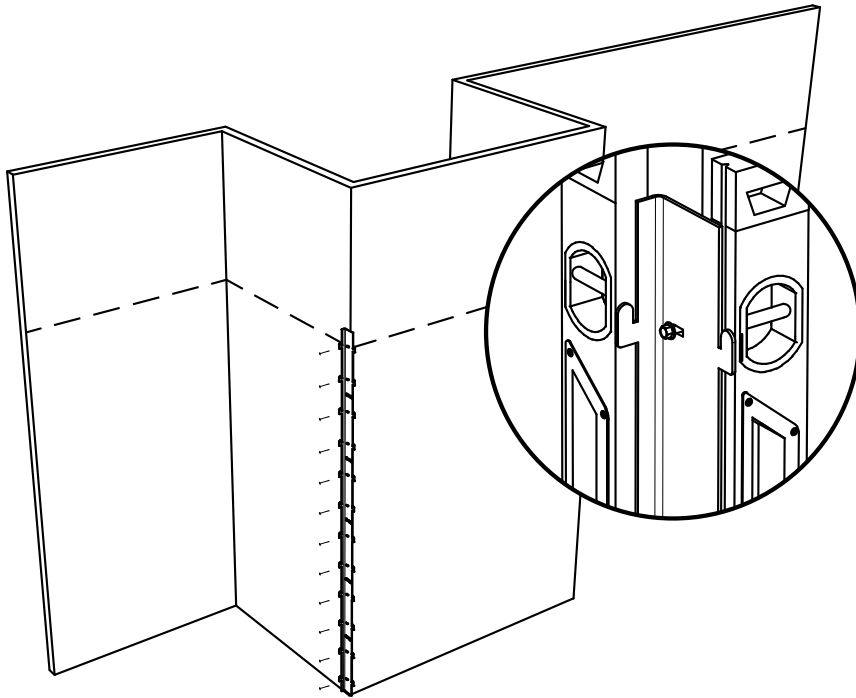

02. Install Brackets for Outside Corners (con't)

Install the adjacent C-Brackets. Repeat as needed until all outside Corner Brackets for your project are mounted.

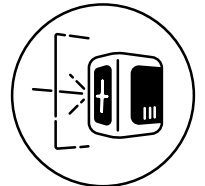
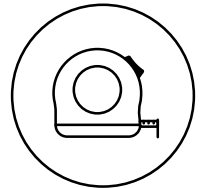
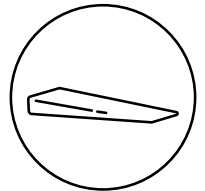
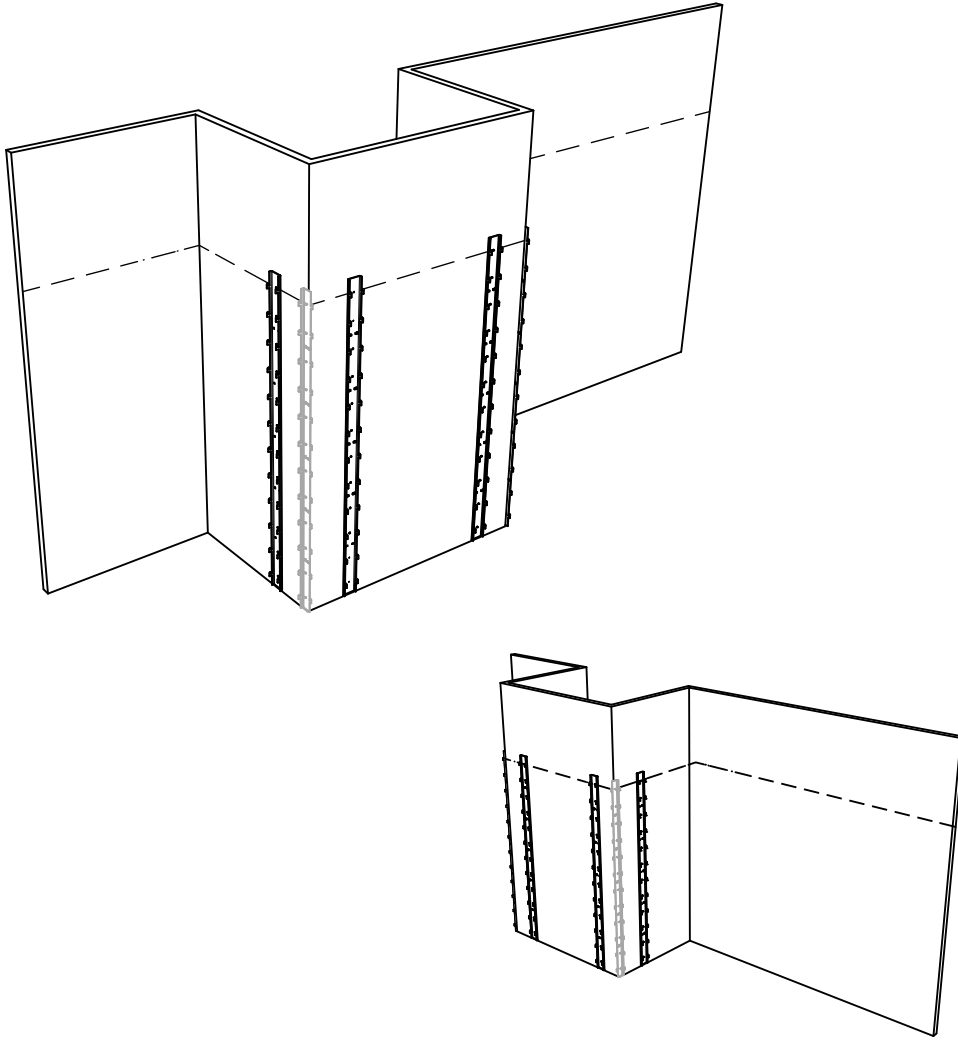

03. Install Brackets for Inside Corners

If your project does not require inside corners, skip to the next section.

Mount the required End Brackets and C-Brackets to the wall. Do not tighten the fasteners.

Tune the position of the brackets. Measure to ensure that the brackets are straight and plumb. Shim the brackets if necessary.

Ensure that any vertically stacked brackets are properly spaced and remain aligned.

Tighten all fasteners.

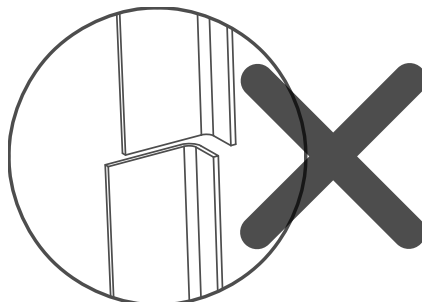
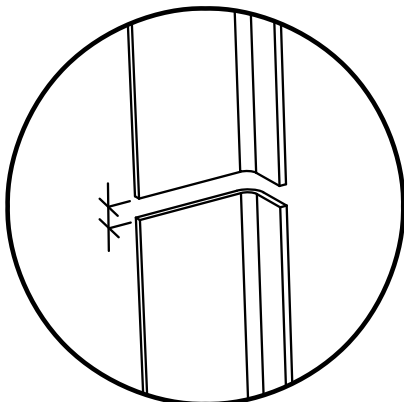
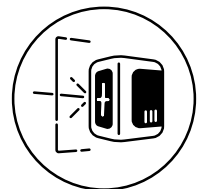
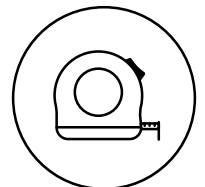
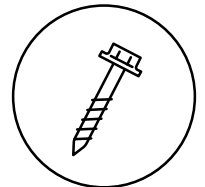
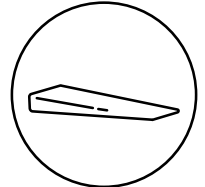
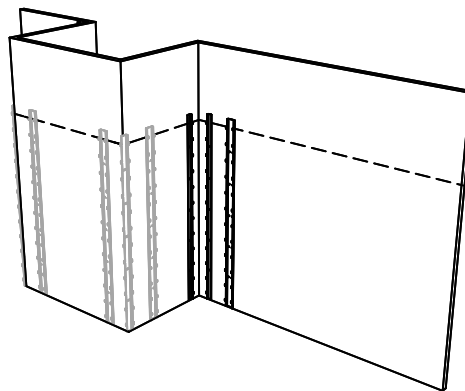
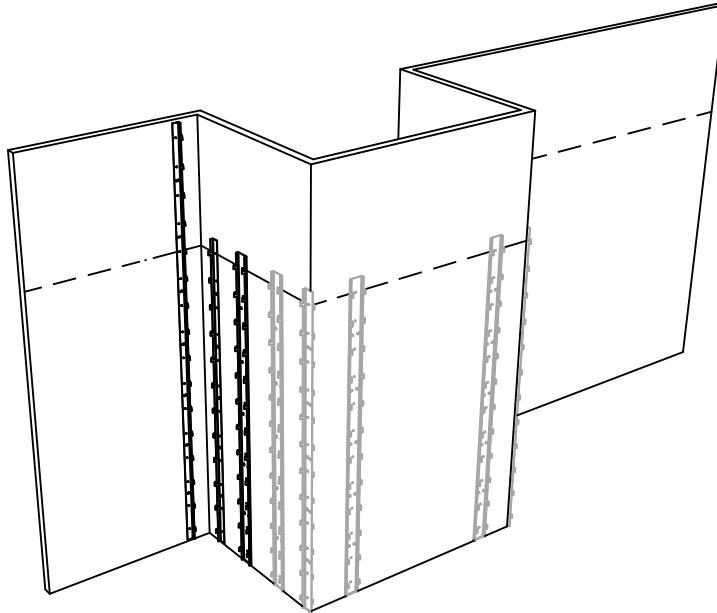

04. Install Brackets for Edge of Scope

Mount the End Brackets to the wall. Do not tighten the fasteners.

Tune the position of the brackets. Measure to ensure that the brackets are straight and plumb. Shim the brackets if necessary.

Ensure that any vertically stacked brackets are properly spaced and remain aligned.

Tighten all fasteners.

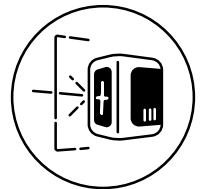
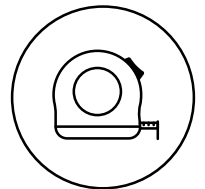
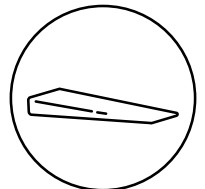
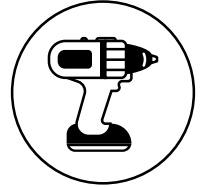
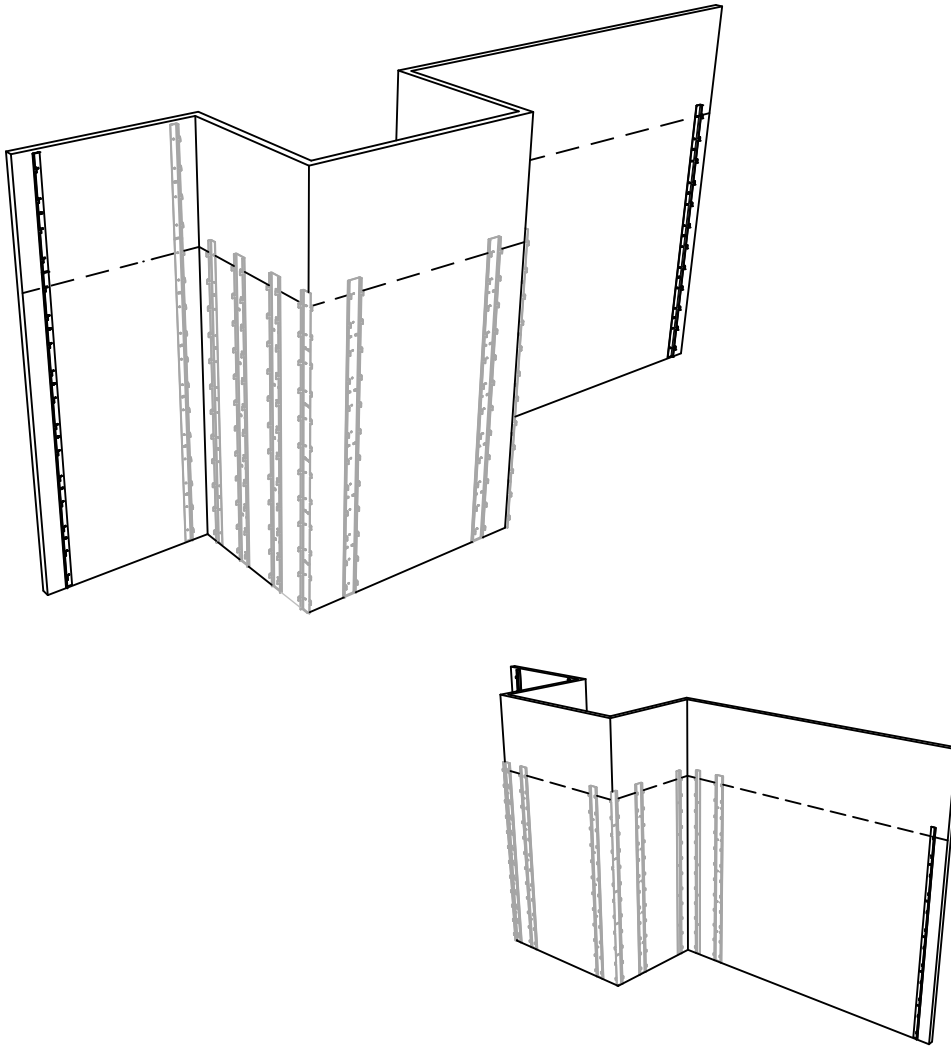

05. Install C-Brackets

Position the c-brackets between the End Brackets. Measure to ensure that the C-Brackets are straight and plumb, then mark the hole centers through the fastener slots in the hardware. Mount the C-Brackets to the wall.

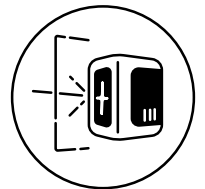
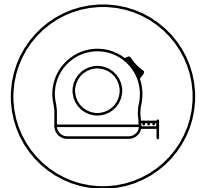
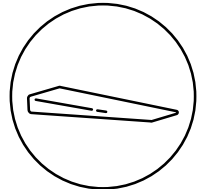
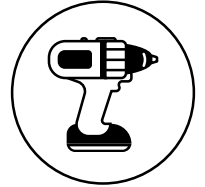
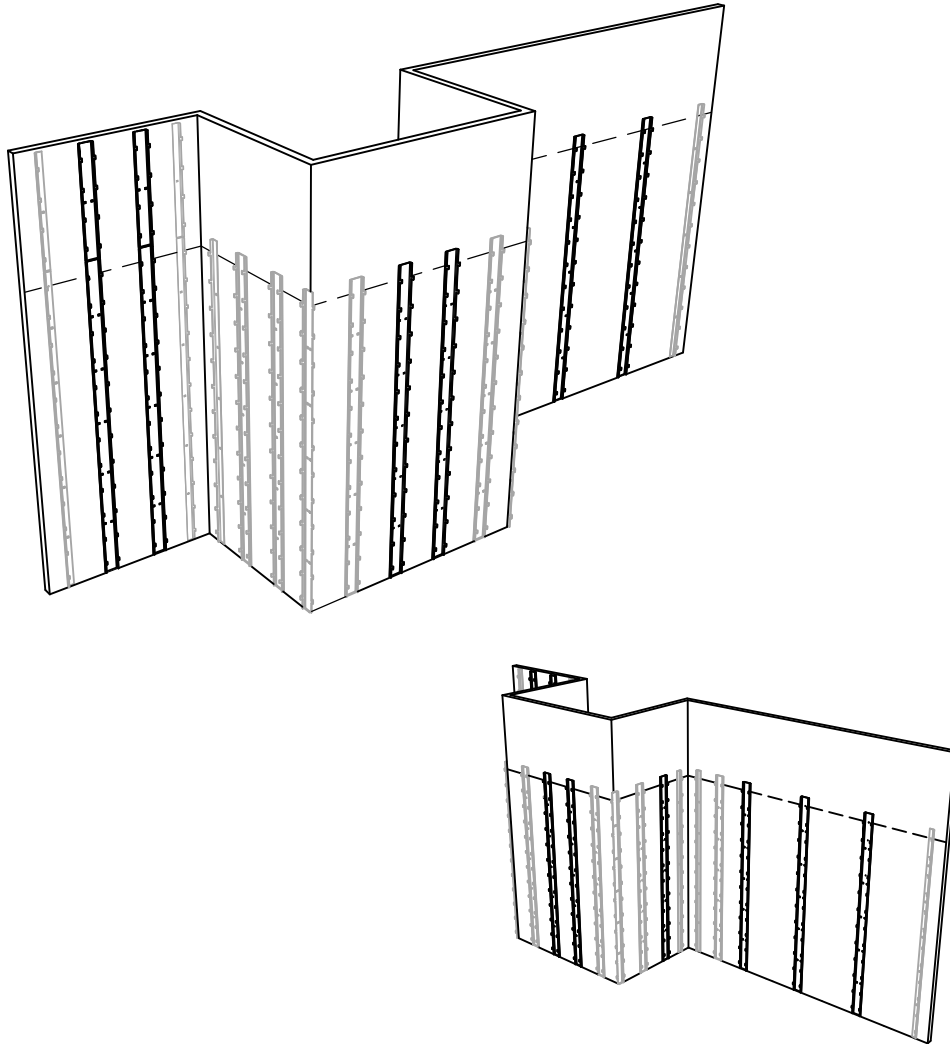

Check hardware positions and alignment



Before proceeding with the installation of the reveal covers and panels, Zahner recommends completing the following checklist to ensure that all Moda hardware is installed straight, level and plumb, with correct alignment and spacing.

- Hardware brackets are aligned with a common horizontal.**

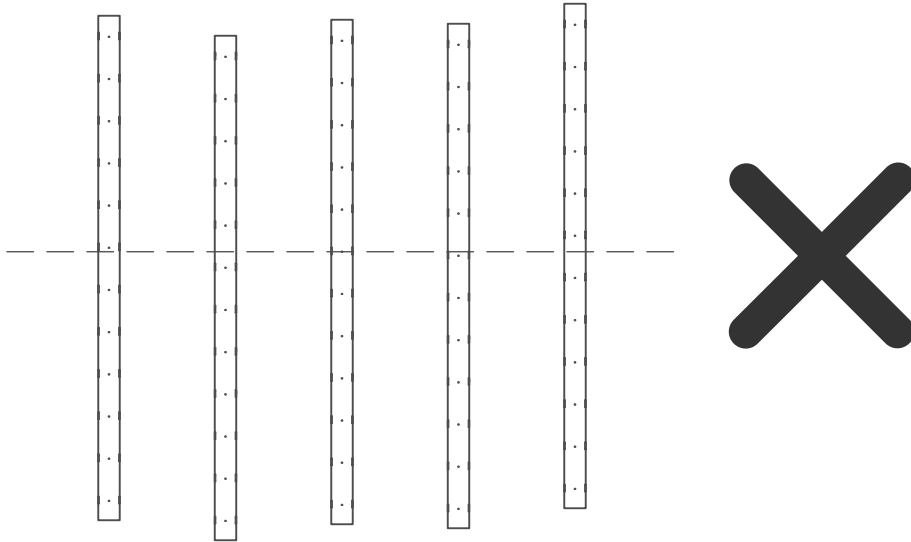

- Hardware brackets are flat, straight and plumb to within 1/8" over 9'.**

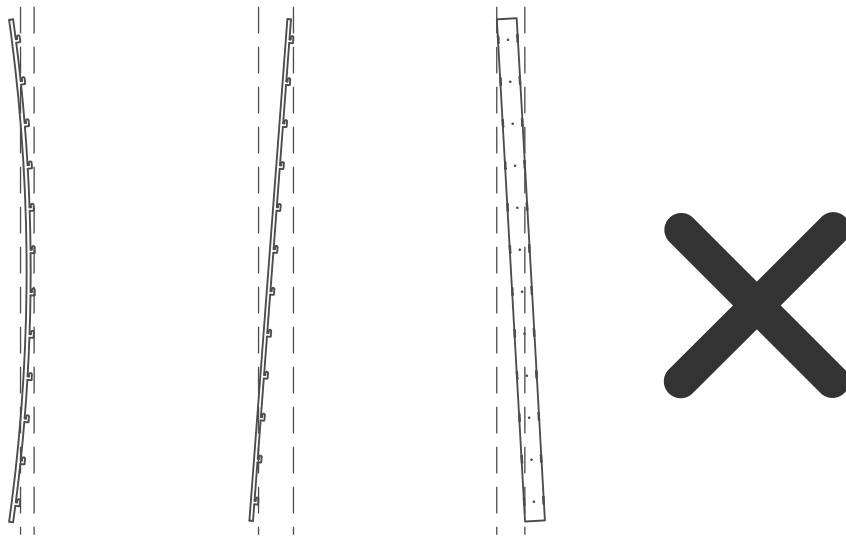

Check hardware positions and alignment (con't)



Before proceeding with the installation of the reveal covers and panels, Zahner recommends completing the following checklist to ensure that all Moda hardware is installed straight, level and plumb, with correct alignment and spacing.

- Hardware brackets are installed so that hooks are aligned across the wall.**

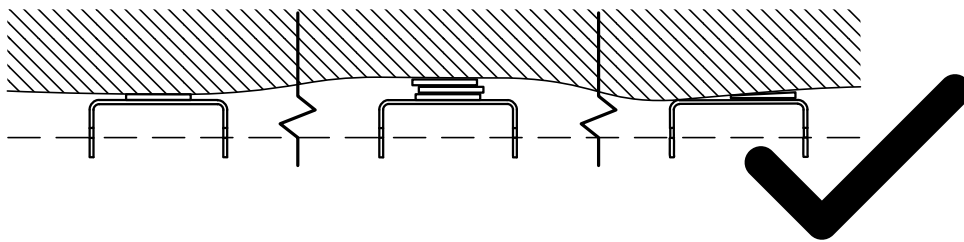
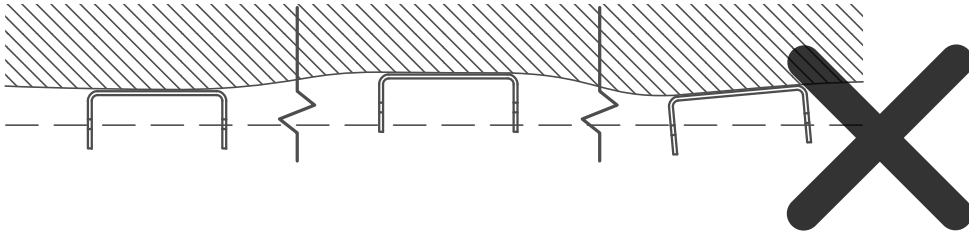

To assist with this inspection, Zahner suggests using the Moda back panel as a secondary method to check that the location and condition of the Moda hardware is compatible with the desired Moda panel arrangement.

06. Install Edge Trim

If your project does not require Edge Trim, skip to the next section.

Orient the trim piece so that the slotted flange is against the wall and pointed towards the nearest End Bracket.

Align the notch just below the fastener slot to the reference horizontal set during Step 01, and mark your fastener locations through the centers of the fastener slots.

Mount the end trim to the wall. Do not tighten the fasteners.

Tune the position of the trim. Use a level to ensure the trim is vertical and plumb. Ensure that any vertically stacked trim is properly spaced and aligned.

Tighten all fasteners.

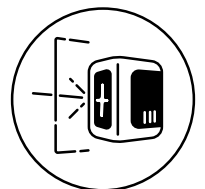
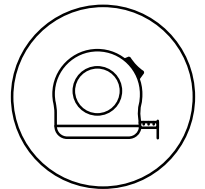
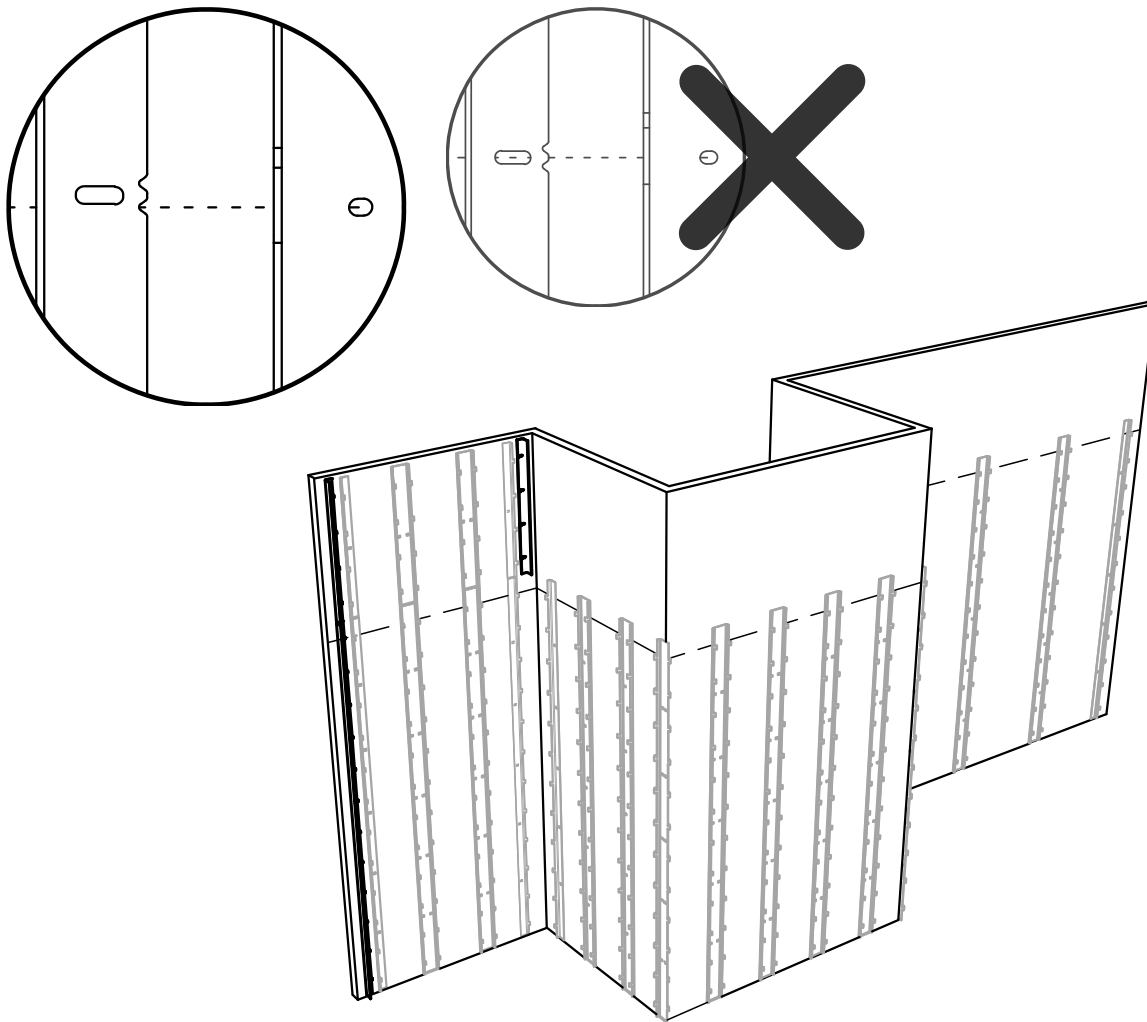

07. Install Reveal Covers

If your project does not require Reveal Covers, skip to the next section.

Locate the C-Brackets in your project that require concealment. Lift the reveal cover into position, insert onto hooks of the C-Bracket and drop into place.

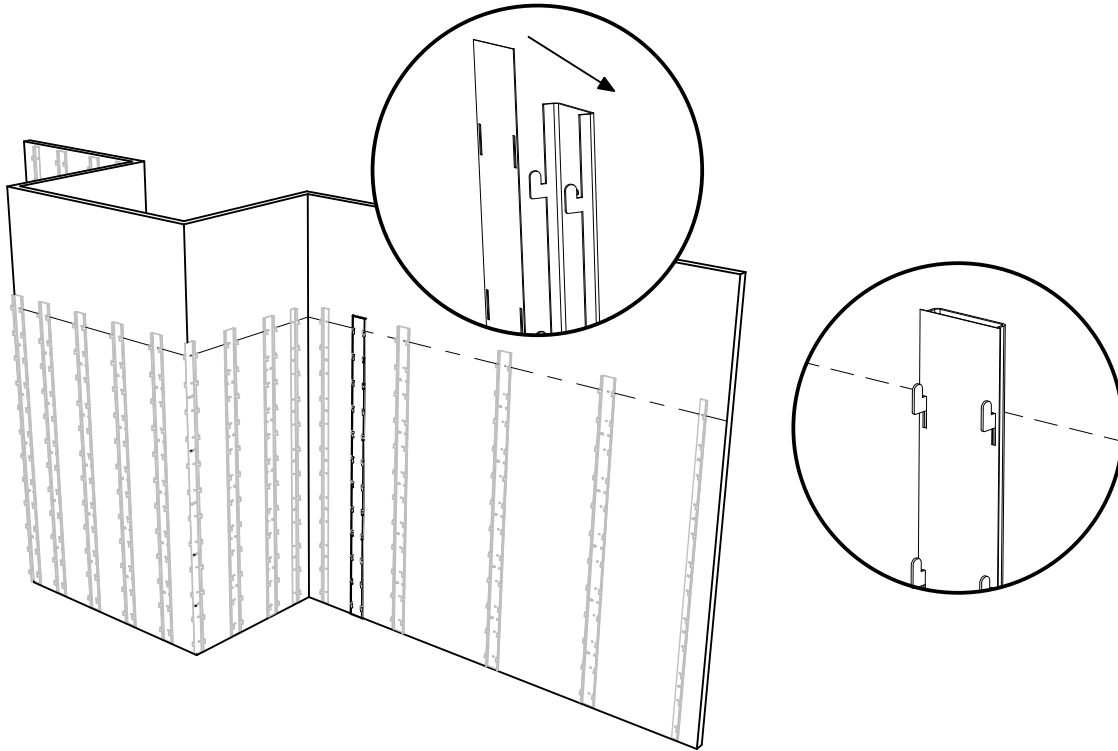

08. Install Panels



Changing Panel Configuration

Moda panels ship from the factory in configuration **O**. Reference the Moda detail set to see if your project requires panels in the **+**, **Δ**, or **□** configuration.



If your project does not require changing the panel configuration, skip to the next step.

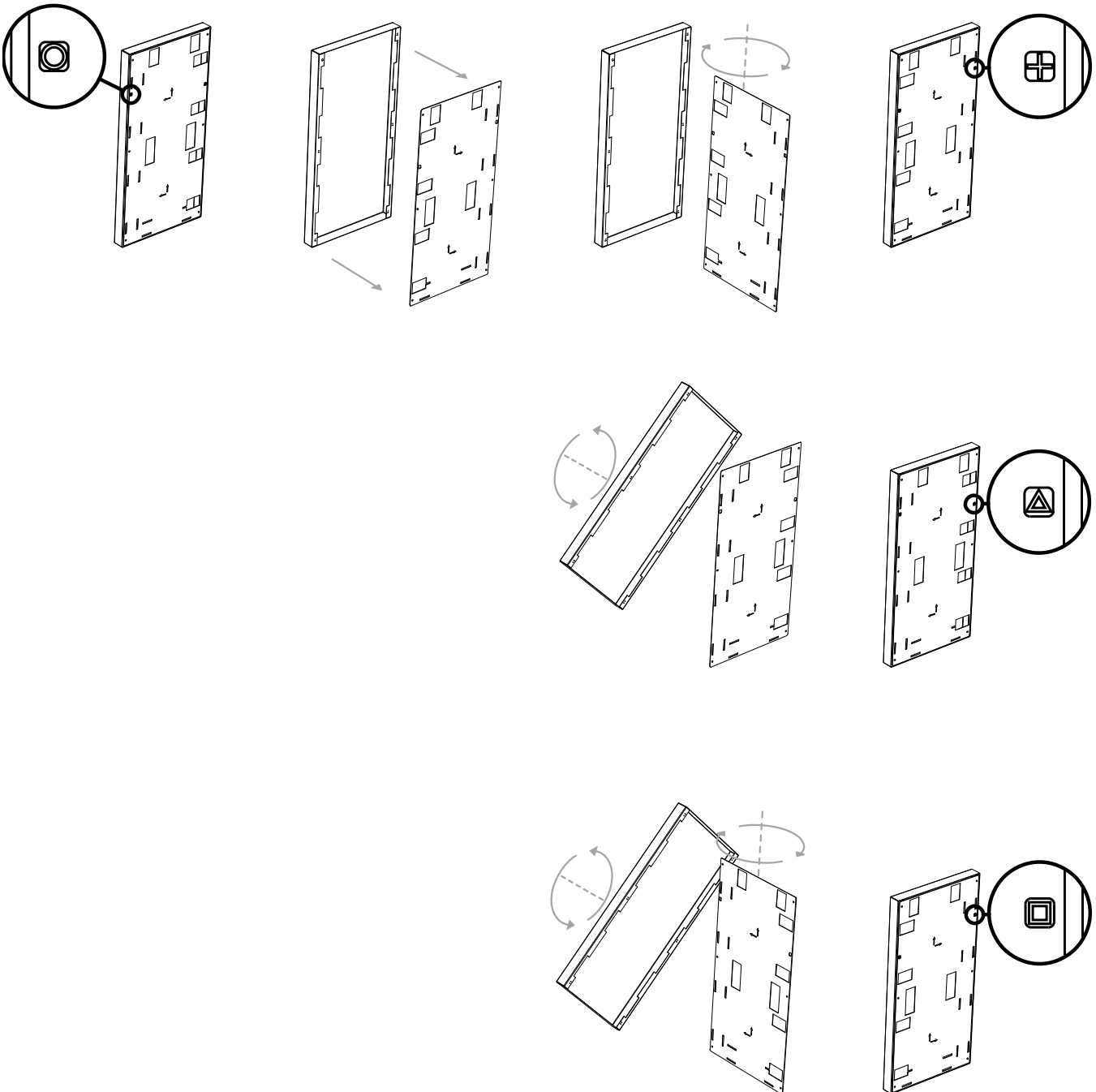

Install Panels (con't)

To prevent the unwanted removal of Moda panels, a locking hook can be added to the back panel prior to the panel's placement on the hardware hooks. This accessory is only necessary for the top row of panels.

Use a sheet metal screw to fasten the locking hook to the back panel using the provided holes. The hook should engage with the hardware where it slots into the panel. For panels on the end of scope, this will most likely be the row of narrow slots closer to the wide slots on the back panel. For panels in the middle of the array, this will most likely be the row of narrow slots closest to the edge of the panel.

Make sure the locking hook is fastened tightly enough to remain attached to the back panel, but is still able to freely rotate around the screw.

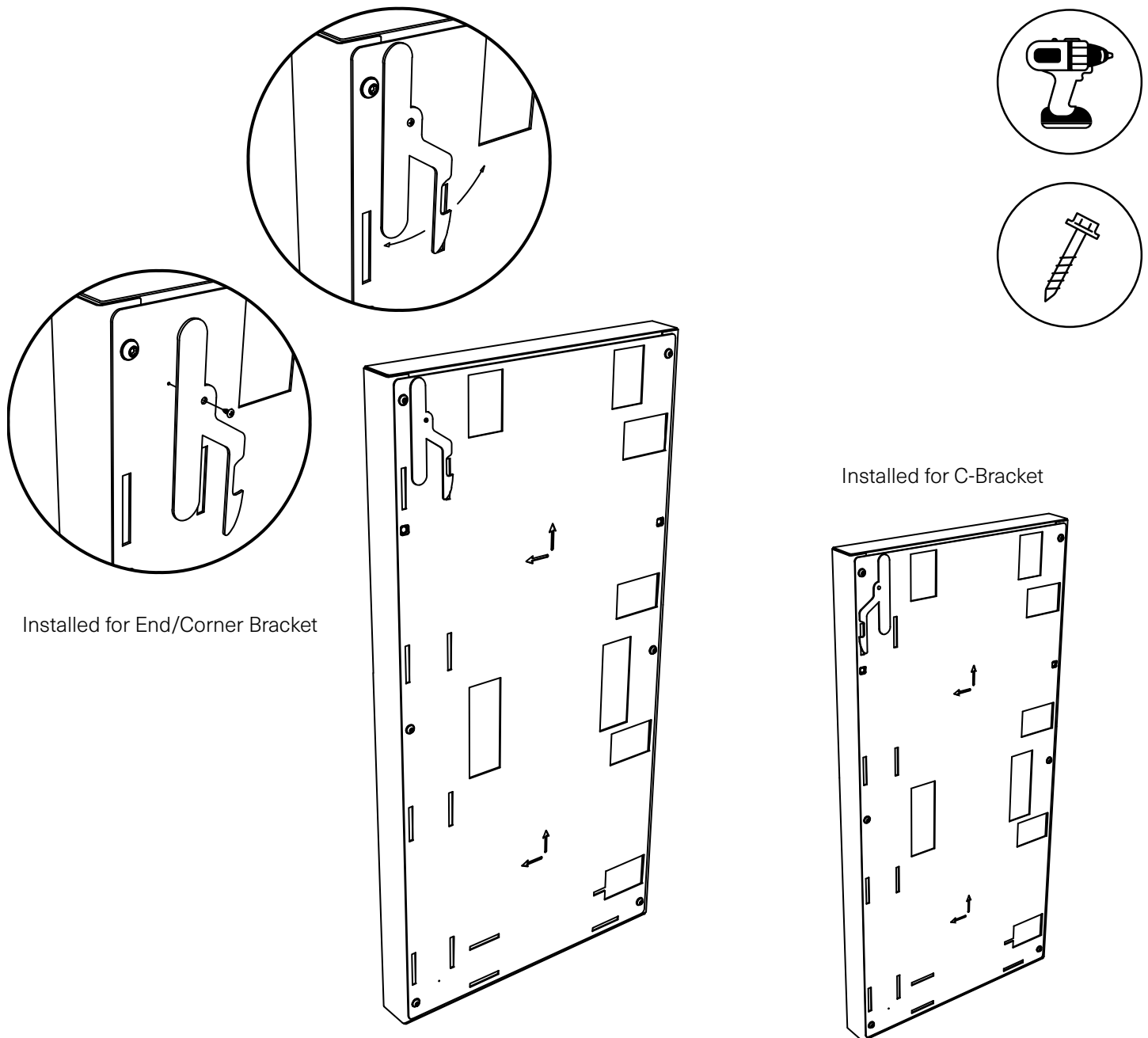

Install Panels (con't)

Make sure the Moda panels are oriented with one of the arrows on the back panel pointing upward.

Align the back panel slots with the bracket mounting hooks, place the panel onto the hooks, and drop the panel into place.

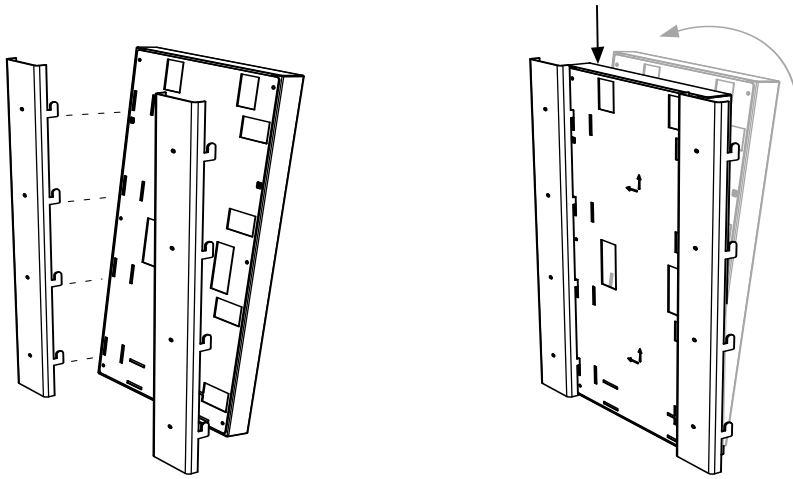

Install the remaining panels. If your layout contains more than 1 row of panels, install the bottom row(s) first.

